



IceSLEET[®] G6 Stealth

Quick Start Guide

Iceberg-Thermal.com

Box Content

A

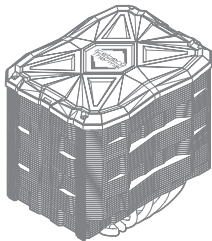

x1

B

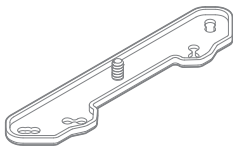

x2

C



x4

D



x4

E



x1

F

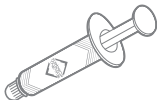

x1

G

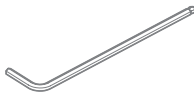

x1

Box Content

AMD

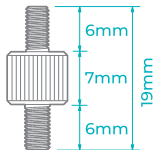
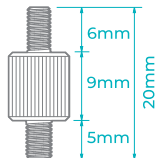
H**x 4****I****x 4**

INTEL

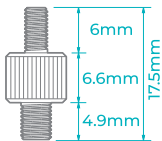
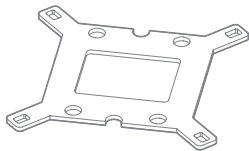
J**x 4****K****x 1****L****x 4****M****x 4****N****x 4**

AMD

AM4

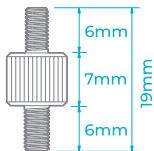
B**D****H**

AM3(+)/AM2(+)/FM2(+)/FM1

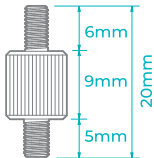
B**D****I**

AMD

AM4

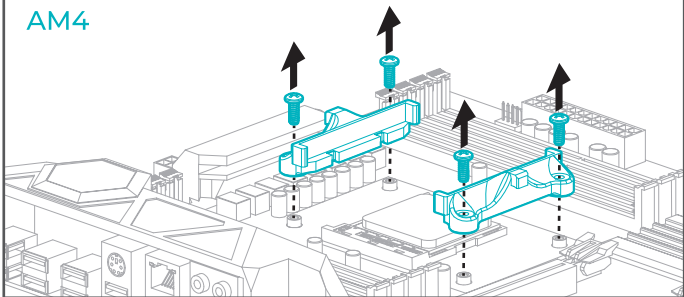

AM3(+) / AM2(+) / FM2(+) / FM1

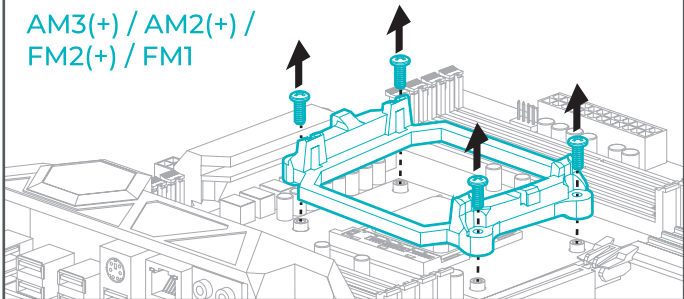

AMD

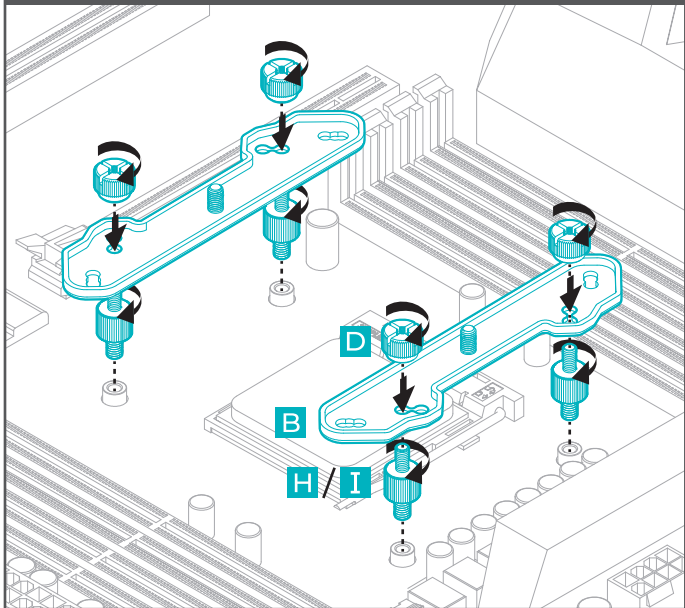

INTEL

LGA 2066 / 2011-0 / 2011-3 (Square ILM)

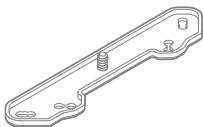
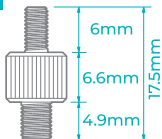
B**D****J**

LGA 1700 / 1200 / 115X

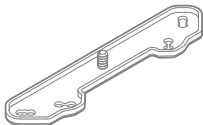
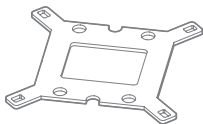
B**D****K****L****M****N**

INTEL

B



K

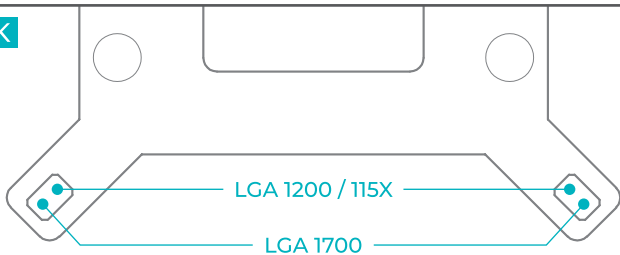

INTEL

LGA 2066 / 2011-0 / 2011-3 (Square ILM)

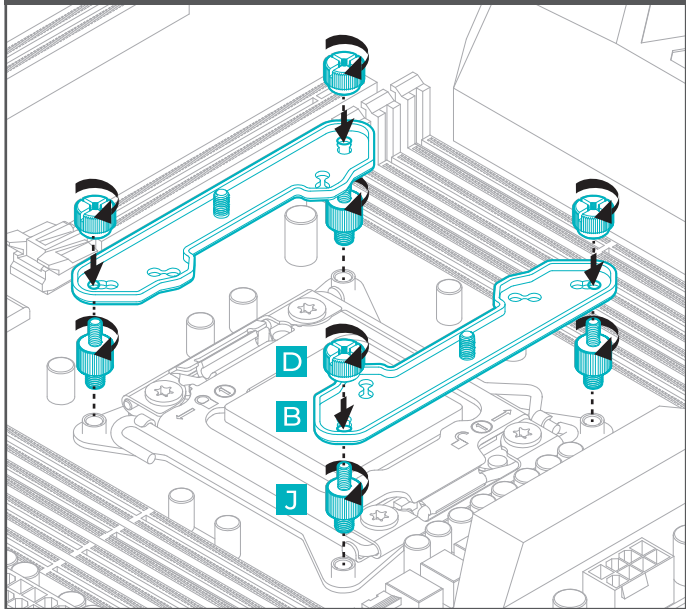

INTEL

LGA 1700 / 1200 / 115X

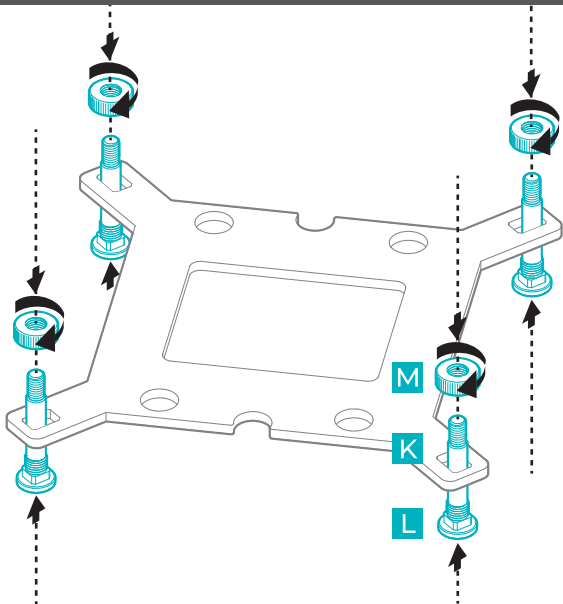

INTEL

LGA 1700 / 1200 / 115X

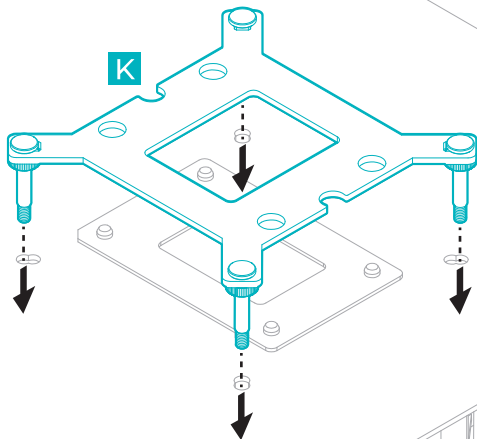

INTEL

LGA 1700 / 1200 / 115X

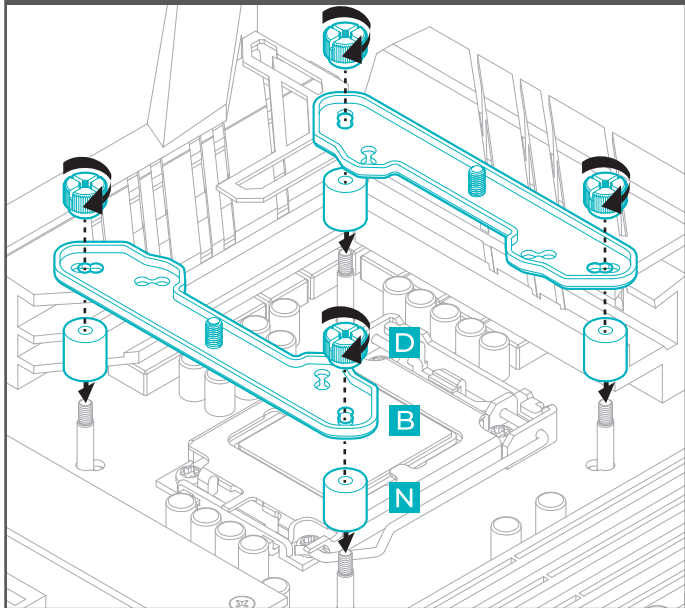

Step 1

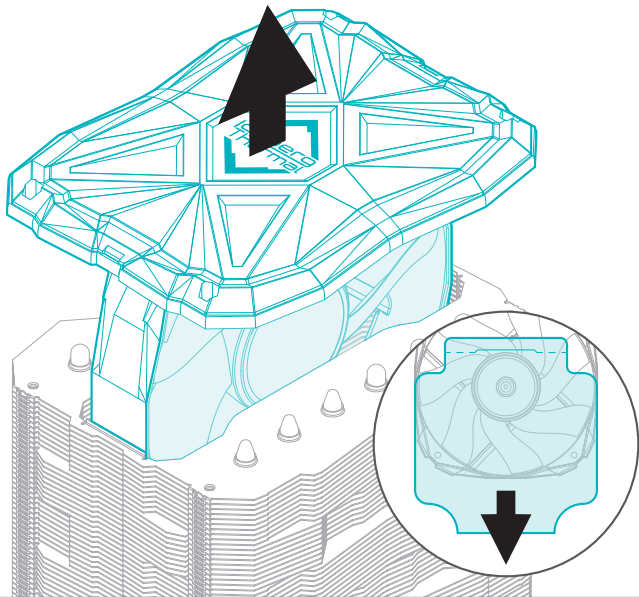

Step 2

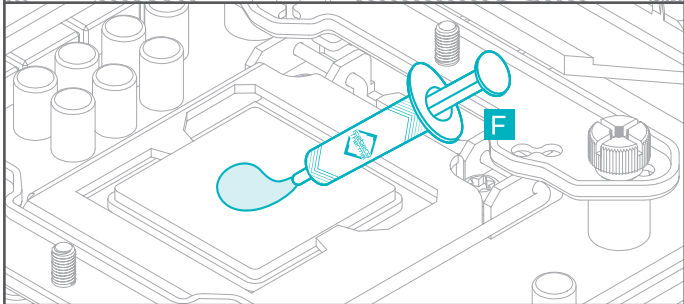
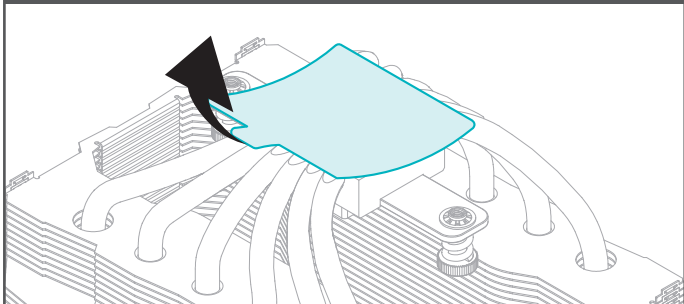

Step 3

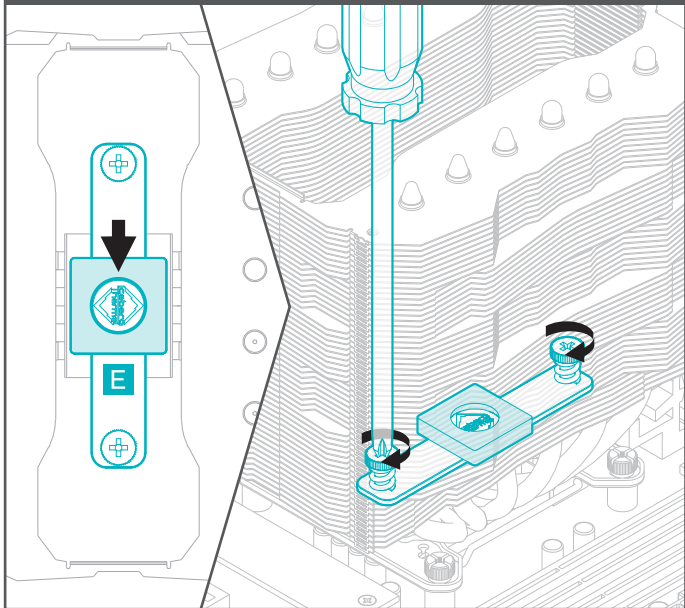

Step 4

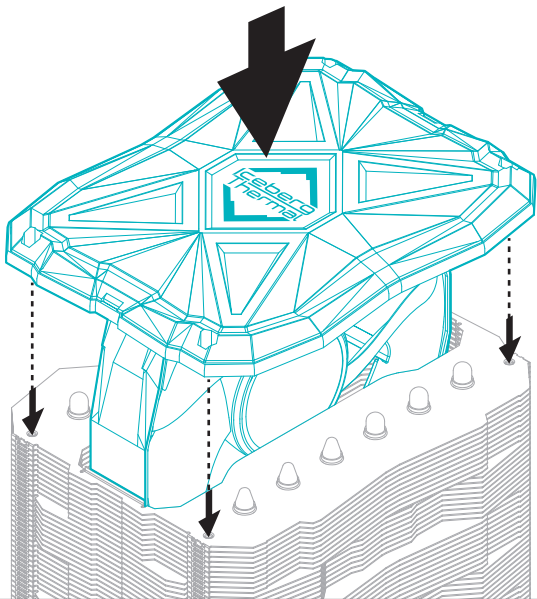

Step 5

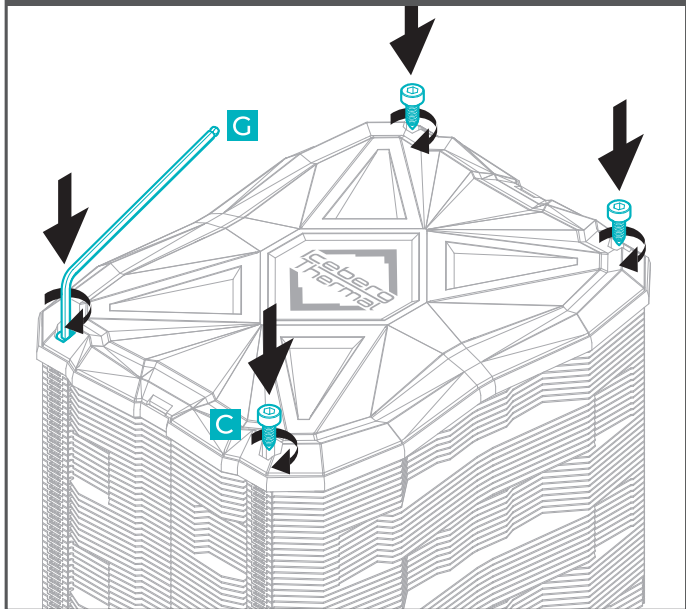

Step 6

